

L'Accents BY DEKOR® Lighting Installation Instructions

PARTS

A 5.5" x 5.5" Inlay



Illusions

» 20", 5', 10', 20', 40', and 60' male to male connection/extension wires and connectors sold separately. Use all DEKOR® Lighting 2-wire cables and splitters with these lights.

B 1.5" x 5.5" Stair Riser



Willow

C Rail Light



Cosmic

D Splitter Options

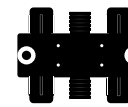

6-Port



Female-to-Female



T-Splitter

LIGHTING AND WIRING OVERVIEW

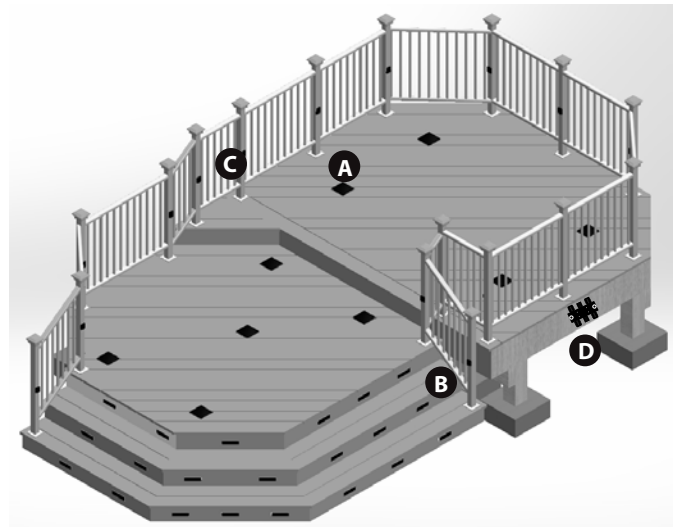

TOOLS NEEDED



NOTE: All cables and splitters are mounted to inside of framing, picture is just representation of where to place these in general.

NOTE: Avoid railing brackets and locations for deck rail lights when running wires up posts.

NOTE: It is recommended to install cables and splitters before decking and railing have been installed.

DO NOT run cables between joists and deck boards.

HELPFUL TIPS

- » Follow the appropriate building and electrical codes when installing all DEKOR® lighting products.
- » Leave wire slack to make fixture terminations.
- » Inlay is for creating unique designs in the floor, stair risers are for safety and the railing lights are for amazing ambiance.
- » It is recommended to determine placement of lighting under dark conditions prior to cutting or drilling/installation.
- » Rail lights can fit on any size of post whether it's a wood, metal, aluminum or composite.
- » Carefully drill holes and notches for each different type of light fixture.
- » NOTE: Please use provided template guide to notch the precise hole for the inlay and the stair riser.
- » Use T-splitters or 6-port splitters at each lights and depending on spacing, in between each inlay, stair riser or rail lighting.
- » Unused splitter female connections need to be capped. Either use provided caps or a weather resistant silicone to prevent corrosion or water damage.

- » The 6-port splitters have 1 input port and 5 output ports. The T-splitters have 1 input port and 2 out put ports. The female-to-female is designed to extend cable lengths.
- » DO NOT use more than one transformer on each circuit.
- » Each light has a pigtail lead to attached to male-to-male cable. Cable lengths are available in 20", 5', 10', 20', 40' or 60' lengths and has a male connector that plugs into the splitter.
- » To ensure all components are in working condition, it is recommended to have power source attached when installing lights.

CAUTION:

When making a connection between a Plug-N-Play connector or a splitter, observe the polarity key to make the proper connection. must match up. **DO NOT** force the connectors together. Plug-N-Play connectors are waterproof, but all used ports must be cap with the provided caps or dielectric grease.

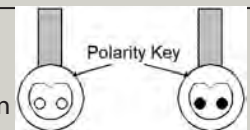

L'Accents BY DEKOR® Lighting Installation Instructions

General Information

- » ALWAYS check local codes before beginning your project. USE DEKOR® TRANSFORMERS for the Limited Lifetime warranty. Using any other type of transformer will void the warranty.

TRANSFORMER CAPACITY BY TYPE		
Example	5A Transformer EZ Max Transformer	2.5A Transformer EZ Transformer
Inlay Light	9	5
Rail Light	10	6

The list above is for maximum number of each individual types of lights. If mixing and matching lighting reference the transformer calculator at www.dekorlighting.com.

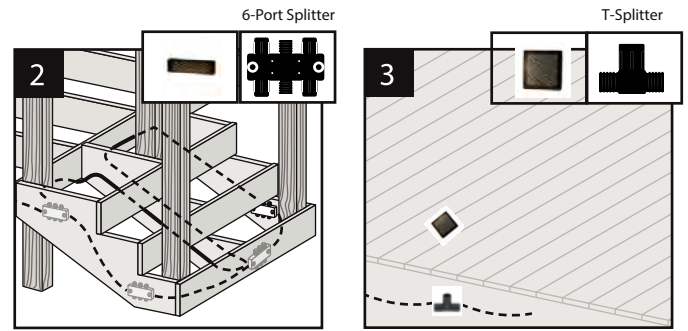

- Cables can be run under deck and behind risers. Use cable staples at least 1/4" (0.6 cm) wide to staple cables to frame. DO NOT crush cable insulation with staple. The 6-port splitters are best used when you have multiple lights in one area, such as stairs. Connect the 6" (15.2 cm) female pigtail from light into the male-to-male cable.
- T-splitters are best used when lights are spaced 6 feet or more apart from each other. Connect the 6" (15.2 cm) female pigtail from light into the male-to-male cable. Staple cables to frame with cable staples at least 1/4" (0.6 cm) wide. DO NOT crush cable insulation with staple.

Planning

NOTE: Prior to installing, plan locations of lights, power supply, timer, and dimmer. These need to be accessible for service. It is required to install a GFCI to help prevent damage to lights caused by electrical surges.

- Dimmer remote works in a 30' (9 m) radius of the unit.
- Install dimmer in a dry location.
- You must install timer vertically with receptacle facing down. Timer must be at least 1' (.305 m) from ground level when installed as per federal safety code height regulations. To use the dusk/dawn feature the timer must be in view of the sun.

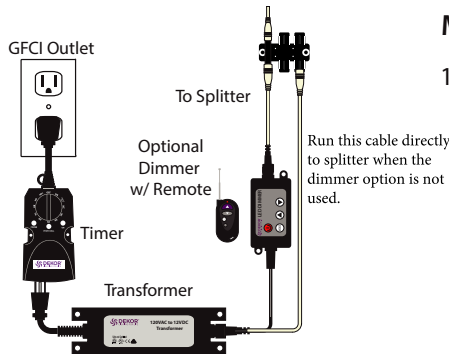

Installing Wiring

NOTE: It is best to install cables and splitters before railing and decking have been installed. Connect to each required splitter using male-to-male cables (lengths vary).

- You must run cables under decking structure and behind stringers. DO NOT run cables between joists and deck boards. Use cable staples at least 1/4" (0.6 cm) wide to staple to frame. DO NOT crush cable insulation with staple.

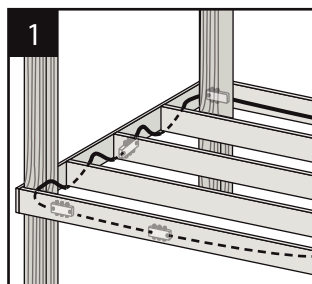

Making Connections

- Using hardware provided, install splitters to inside of framing. Install where lighting is present and depending on spacing in between each riser and recessed light.

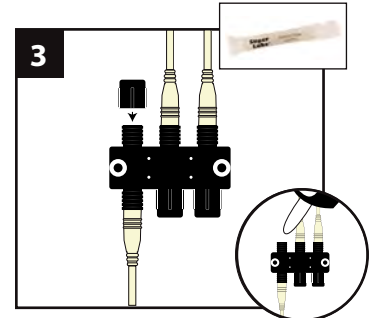
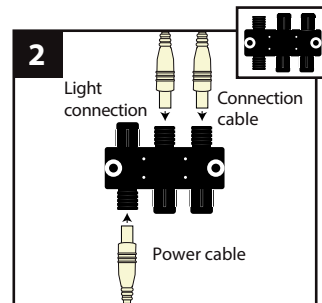
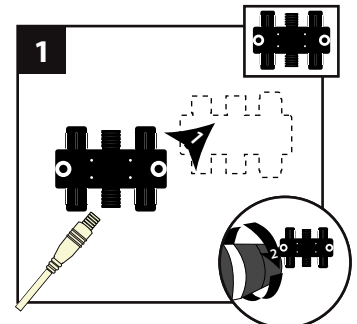

- Attach male cable from lights to female connections on splitter. Attach male-to-male connection cable in between each splitter. Continue until all wiring from lights to splitters and connector cables.
- Cap all unused female port on splitter using the provided caps.

How to install L'Accents Rail lights

NOTE: Drill holes in post prior to mounting. It is easier to thread the cables through the post.

1. Mark location for light, typically 28" above floor. Drill one 1/2" hole to allow cable to pass through the post.

Note: For composite sleeves the cables will need to be fished through between the inside structural post and post sleeve. Check local codes for lighting requirements.

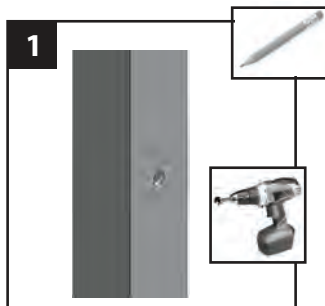

2. Connect the male cable that was installed in post to the 6" female pigtail on the light. Push cable through hole and mount the light lens and back plate to the post with the provided screws.

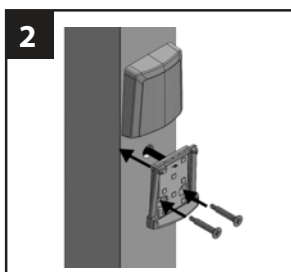

3. Slide the front faceplate over the ridges and snap into place until the bottom of the faceplate is flush with the clear lens.

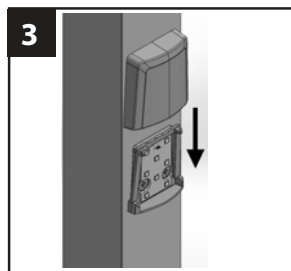

Center Point Load: 300 Pounds on Inlay and Stair Riser.

Note: Point load is the amount of weight the faceplate can handle in a 1/2" center press.

How to install L'Accents Stair Riser Light

1. Decide on the location of your stair riser lights. At this location measure between the stair stringers and cut a minimum 2 x 8 brace to install vertically between the stair stringers. Fasten brace using (2) 3" deck screws into the side of the stringers. Drill a 1/2" hole in bracing to allow the 6" female pigtail to pass through.

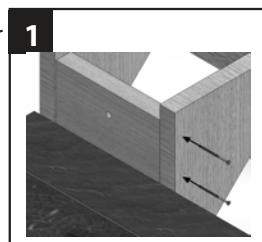

2. Cut out stair riser material to fit the base precisely to its shape (use the provided template guide). The brace needs to be placed to accommodate the thickness of the stair riser material. If it is less than 7/8", move the brace back so that the stair riser is flush with the stair riser material.

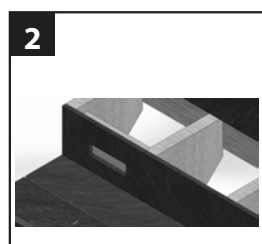

3. Mount the stair riser base in the notched area to the back brace using the provided 1 1/2" screws.

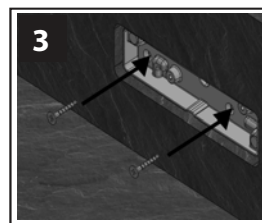

4. Connect 6" female pigtail to male cable, push through the 1/2" hole and mount the LED board to base with the provided 1/2" screws.

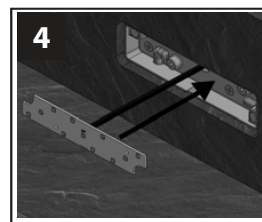

5. Install the front faceplate onto the base. Make sure the key tab on the faceplate is matched up with the notch in the base.

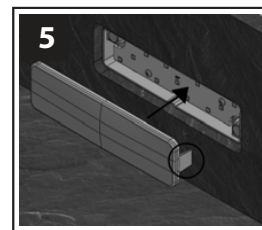

Note: The base has a notch on one side to accommodate the key tab on the faceplate.

L'Accents BY DEKOR® Lighting Installation Instructions

How to install the L'Accents Inlay Light

1. Decide on the location of the inlay lights. At this location cut a minimum 2 x 8 brace to install horizontal between the joists. Mount the base onto brace and drill one 1/2" hole to allow the cable to pass through the base and the brace.

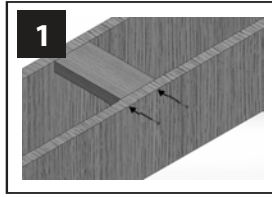

2. Cut out the deck boards around the inlay (use the provided template guide to make your cutting marks). The brace needs to be placed to accommodate the thickness of the deck board. If deck board is 15/16" thick place the block flush with the top of the frame joist.

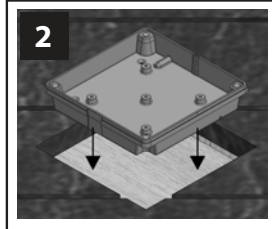

Note: adjust brace accordingly to match your deck board thickness.

3. Connect the 6" female pigtail to the male cable and push through the 1/2" drilled hole and mount the LED board using the 1/2" provided screws.

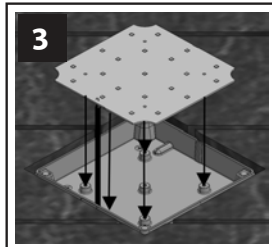

4. Install the front faceplate onto the base. Make sure the key tab on the faceplate is matched up with the notch in the base.

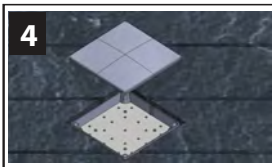

Note: The base will have a notch on one side to accommodate the key tab on the faceplate.

Import Installation Information

- » The end user is responsible for following local building codes.
- » All lighting fixtures must be connected using DEKOR® cables and splitters.
- » L'Accents by DEKOR® cables and splitters are intended for burial less than 6 inches.
- » L'Accents by DEKOR® light fixtures have a 1/2" hole to accommodate a conduit fitting. See image 1A.

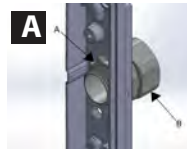

How to use the template guide

1. Determine the location of your inlay or stair riser lights. Place the template guide on your desired location and use a carpenter's square to line up the template guide to the deck board or your stair riser fascia material.

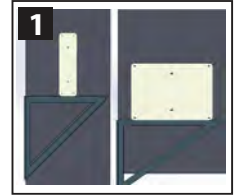

2. There are two center set holes in the template guide to secure into place. Using a #8 wood screw, drive screws through the holes and into the deck board or stair riser fascia material. **Note: DO NOT** over tighten screw to avoid breaking the template guide.

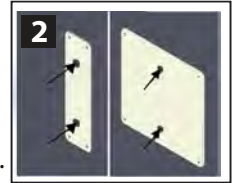

3. After the template guide is secure, use a pencil to scribe the perimeter edge of the template guide. Then mark the four outside corner holes to locate drill points. Remove template guide.

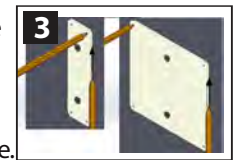

4. Using a 1/8" pilot drill bit, drill through material in the marks on the four corners. Follow through the pilot holes using a 1/2" drill bit. This will complete the hole size to match the radius corners of the inlay and stair riser housing and faceplate.

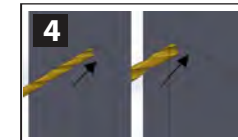

5. Using a jigsaw, cut the four perimeter marks you scribed from the template guide. This is the final step to complete the cut out for both the inlay and the stair riser.

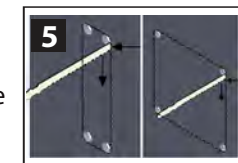

Note: Cutting the inside of the marks, the inlay and stair riser will fit tight, cutting through the marks, the inlay and stair riser will have a small gap around the perimeter.